

Valerie Schweiger  
+49 151 1617 4714  
v.schweiger@tjiko.de



Designlinien

BIM - Konfigurator

Tjiko GmbH | Riedstraße 12 | 83126 Flintsbach am Inn | www.tjiko.de

## Module mit Dusche

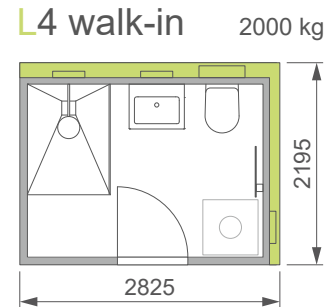
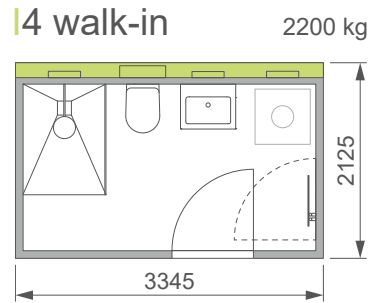
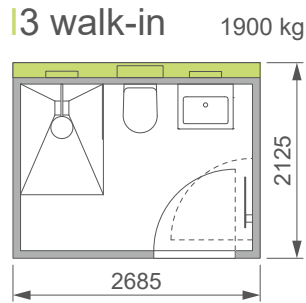
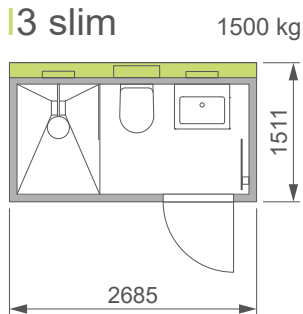

## Module mit Badewanne

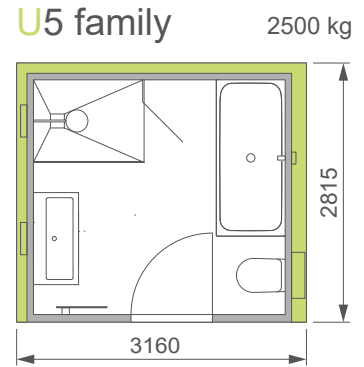
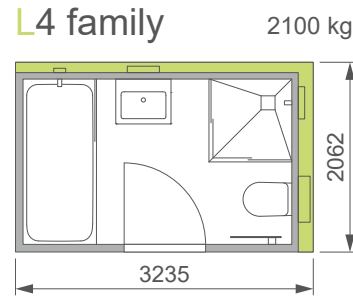
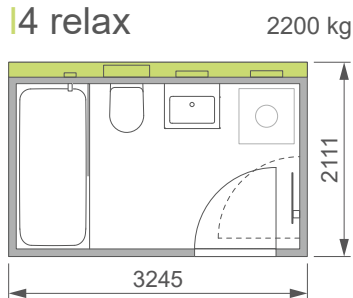
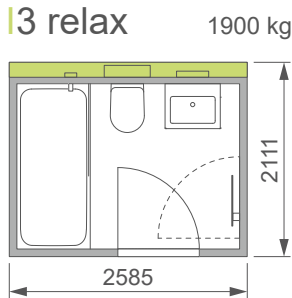

## Gästemodule

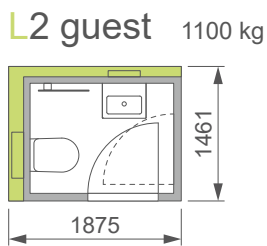
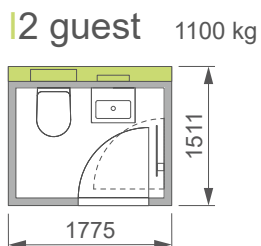

## Höhenmaße

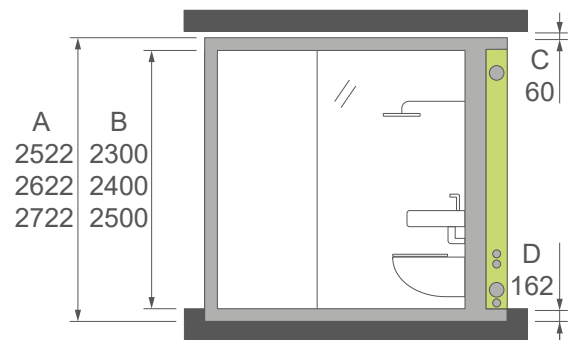

Installationsebene

A = Außenmaße    C = Freiraum über Modul  
B = Innenmaße    D = Fußbodenaufbau

Module mit großer Bewegungsfläche



L3 open+

1700 kg

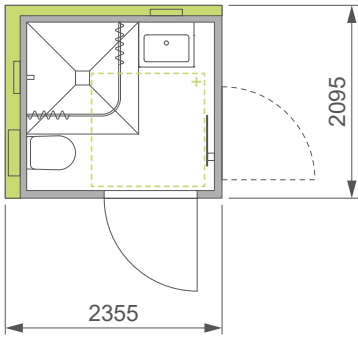

L4 open+

2300 kg

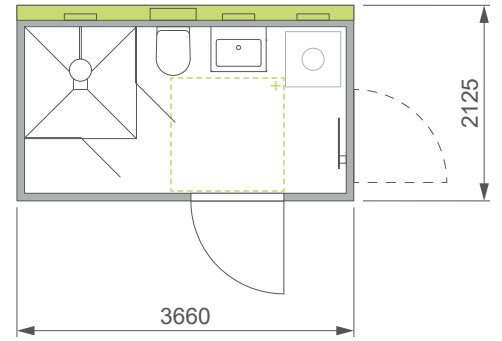

L3 open+

2000 kg

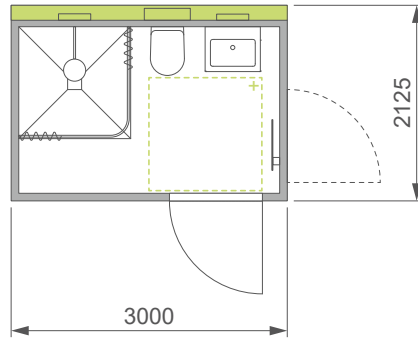

L3 openR

2100 kg

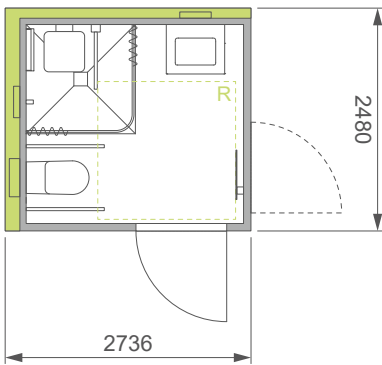

Bewegungsfläche  
1200 x 1200  
Nachrüstbare  
Griffe



Bewegungsfläche  
1500 x 1500  
Barrierefrei  
Montierbare Griffe

Installationsebene

Höhenmaße

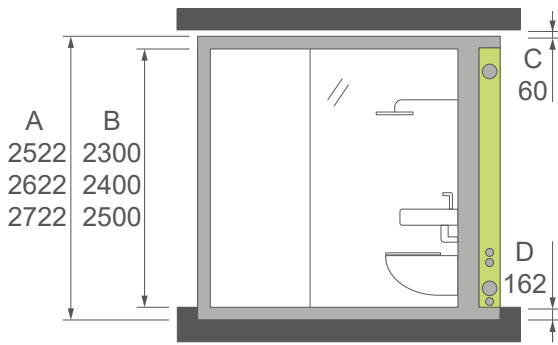

A = Außenmaße    C = Freiraum über Modul  
B = Innenmaße    D = Fußbodenaufbau

Faltanleitung

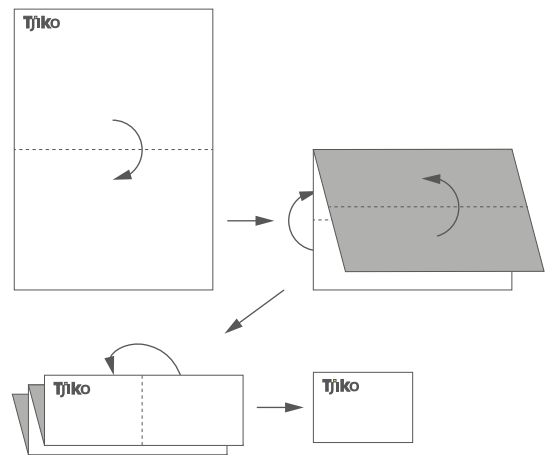

Stockholm

Inverness

Vancouver

Osaka

Zermatt

Melbourne

